

## TECHNICAL DATA SHEETS

### DESCRIPTION

Our plain concrete dobies range in size from 2x2x3/4", all the way up to 5" and 6" in dobies. They come with or without tie wire inserted in the concrete brick. As is the case for all our concrete spacers, we manufacture these in regular strength, 4000 psi mix design, or higher strength for custom jobs.

### APPLICATION

- On grade

### FEATURES

- Cover Heights from 3/4" to 6"
- Particularly suited for on-grade reinforcement.
- Standard 4000 PSI (additional strength available at added cost).
- Custom sizes and configurations available upon request.
- D.O.T. approved (in most states).
- Meets all requirements and qualifies as a CRSI Class 1 Bar Support.

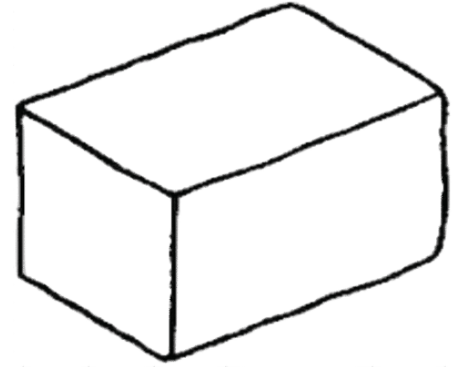



### PRODUCT INFORMATION

**MADE IN THE USA**

Item	Description	Cover Height	Quantity / Pallet	Quantity / Bag	Weight (lbs / pallet)
CPD075	2" x 2" x 3/4"	3/4"	12,000	160	3,600
CPD100	2" x 2" x 3/4"	1"	9,600	160	3,600
CPD150	2" x 2" x 1 1/2"	1 1/2"	5,760	96	3,000
CPD175	2" x 2" x 1 3/4"	1 3/4"	4,800	80	3,000
CPD200	2" x 2" x 2"	2"	4,800	80	3,250
CPD233	2" x 3" x 3"	2" or 3"	2,112	N/A	3,250
CPD247	2" x 4" x 7"	2", 4" or 7"	684	N/A	3,220
CPD300	3" x 3" x 3"	3"	1,536	N/A	3,250
CPD500	3" x 5" x 5"	5"	540	N/A	3,700
CPD600	3" x 6" x 6"	6"	35	N/A	3,100
CPD6606	6" x 6" x 6"	6"	100	N/A	3,150

### MANUFACTURER INFORMATION

 (909) 356-5399

 (909) 726-9500

 [info@inlandconcreteproducts.com](mailto:info@inlandconcreteproducts.com)

See user information at [inlandconcreteproducts.com](http://inlandconcreteproducts.com)



**Inland Concrete Products**  
14760 Santa Ana Ave.  
Fontana, CA 92337

## TECHNICAL DATA SHEETS

### DESCRIPTION

The concrete dobies with wire are typically similar in size as the plain concrete dobies, with two wires protruding out of the top of the brick for tying to the rebar. These concrete spacers meet all the standard PSI specs and can optionally be ordered with additional strength.

### APPLICATION

- On grade, metal decks
- Side-form spacers, pools.

### FEATURES

- Cover Heights from 3/4" to 4"
- Furnished with two 16 gauge wires for secure attachment.
- Standard 4000 PSI (additional strength available at added cost).
- Custom sizes and configurations available upon request.
- D.O.T. approved (in most states).
- Meets all requirements and qualifies as a CRSI Class 1 Bar Support.

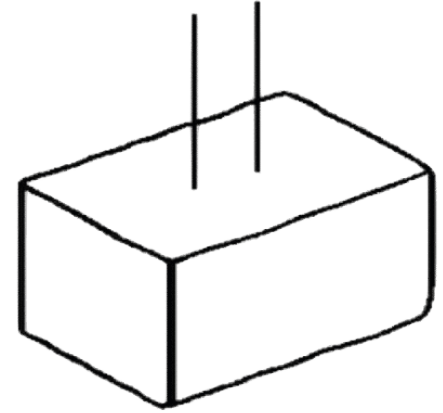



### PRODUCT INFORMATION

**MADE IN THE USA**

Item	Description	Cover Height	Quantity / Pallet	Quantity / Bag	Weight (lbs / pallet)
<b>CWD075</b>	2" x 2" x 3/4"	3/4"	12,000	160	3,500
<b>CWD100</b>	2" x 2" x 1"	1"	8,640	144	3,150
<b>CWD150</b>	2" x 2" x 1 1/2"	1 1/2"	5,760	96	3,050
<b>CWD175</b>	2" x 2" x 1 3/4"	1 3/4"	4,800	80	3,050
<b>CWD200</b>	2" x 2" x 2"	2"	4,800	80	3,350
<b>CWD250</b>	2 1/2" x 2 1/2" x 2 1/2"	2 1/2"	2,142	N/A	2,800
<b>CWD233</b>	2" x 3" x 3"	3"	2,112	N/A	3,500
<b>CWD300</b>	3" x 3" x 3"	3"	1,536	N/A	3,425
<b>CWD345</b>	3" x 4" x 5"	3"	576	N/A	2,800
<b>CWD400</b>	3" x 4" x 3"	4"	1,344	N/A	3,700

### MANUFACTURER INFORMATION

 (909) 356-5399

 (909) 726-9500

 [info@inlandconcreteproducts.com](mailto:info@inlandconcreteproducts.com)

See user information at [inlandconcreteproducts.com](http://inlandconcreteproducts.com)



**Inland Concrete Products**  
14760 Santa Ana Ave.  
Fontana, CA 92337

## TECHNICAL DATA SHEETS

### DESCRIPTION

These concrete dobies have grooves built into them to create a cradle for the rebar to set in. This can create many usable dimensions from one brick. For instance, the 3 x 4 x 3 inch combo has an outside dimension of 3 inches by 4 inches. With the two grooves this product will provide cover heights of 2 ½", 3", 3 ½", and 4". All our concrete spacers meet standard PSI specs and can optionally be customized to add more strength for your specific rebar reinforcement needs.

### APPLICATION

- On grade.

### FEATURES

- Multiple cover heights.
- Designed with multiple heights within a single unit.
- Standard 4000 PSI (additional strength available at added cost).
- D.O.T. approved (in most states).
- Meets all requirements and qualifies as a CRSI Class 1 Bar Support.

### PRODUCT INFORMATION

**MADE IN THE USA**

Item	Description	Quantity / Pallet	Quantity / Bag	Weight (lbs / pallet)
CCD250	1 1/2" x 2" x 2 1/2"	4,800	64	3,700
CCD300	2 1/2" x 3" x 3 1/2" x 4"	1,344	N/A	3,700

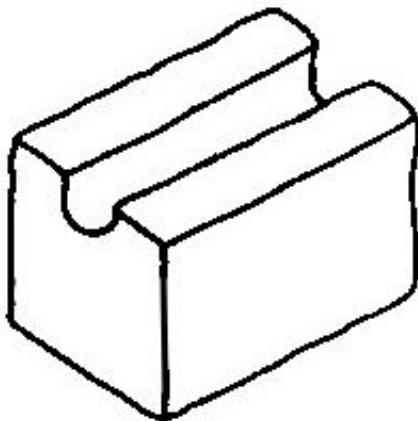

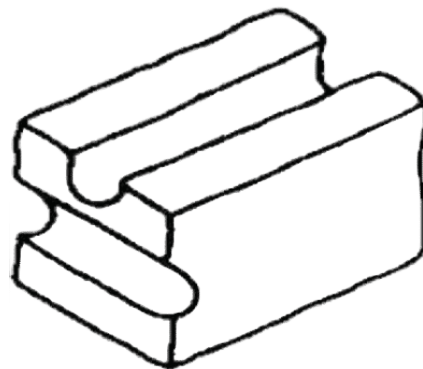

CCD250



CCD300

### MANUFACTURER INFORMATION

 (909) 356-5399

 (909) 726-9500

 [info@inlandconcreteproducts.com](mailto:info@inlandconcreteproducts.com)

See user information at [inlandconcreteproducts.com](http://inlandconcreteproducts.com)



**Inland Concrete Products**  
14760 Santa Ana Ave.  
Fontana, CA 92337

## TECHNICAL DATA SHEETS

### DESCRIPTION

These concrete dobies uniquely support two mats of reinforcement when used with 90 degree bend rebar dowel.

### APPLICATION

- On grade

### FEATURES

- Depth of hole is 1/2" from bottom.
- Ideally suited for heavy rebar mats on-grade.
- Meets standard PSI specs, and like all our concrete spacers, can be custom ordered for increased strength.
- Standard 4000 PSI (Additional strength available at added cost).
- D.O.T. Approved (In most states).
- Meets all requirements and qualifies as a CRSI Class 1 Bar Support.

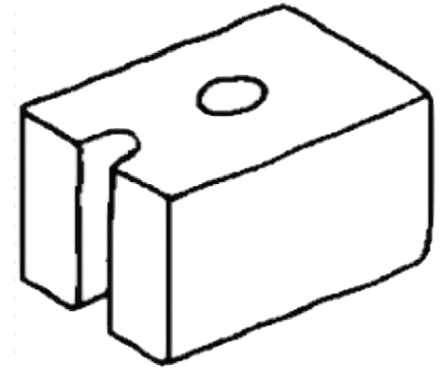



### PRODUCT INFORMATION

**MADE IN THE USA**

Item	Description	Quantity / Pallet	Weight (lbs / pallet)
<b>CDD300</b>	3" x 3 1/2" x 4"	1,280	3,700
<b>CDD500</b>	3" x 4" x 4 1/2" x 5"	756	3,600

### MANUFACTURER INFORMATION

 (909) 356-5399

 (909) 726-9500

 [info@inlandconcreteproducts.com](mailto:info@inlandconcreteproducts.com)

See user information at [inlandconcreteproducts.com](http://inlandconcreteproducts.com)



**Inland Concrete Products**  
14760 Santa Ana Ave.  
Fontana, CA 92337

## TECHNICAL DATA SHEETS

### DESCRIPTION

These are typically used by general contractors in bridge decks and other concrete forming applications. They come in longer sizes such as 24" or 48", and depending on length, will be reinforced with rebar. Form supports are also stocked in 5", 5 1/2", 6", and many other heights. All Spreaders are 3" x 3" dimensions, in lengths from 5 1/2" to 48". Standard Lengths listed below.

### APPLICATION

- Side-Form Spacer & Form Spreader.

### FEATURES

- Cover height from 5 1/2" to 48"
- Made to order to meet most forming widths up to 48"
- Designed to use in forming abutments, walls.
- Standard 4000 PSI (Additional strength available at added cost).
- Custom, non-standard lengths available upon request.
- D.O.T. Approved (In most states).
- Meets all requirements and qualifies as a CRSI Class 1 Bar Support.

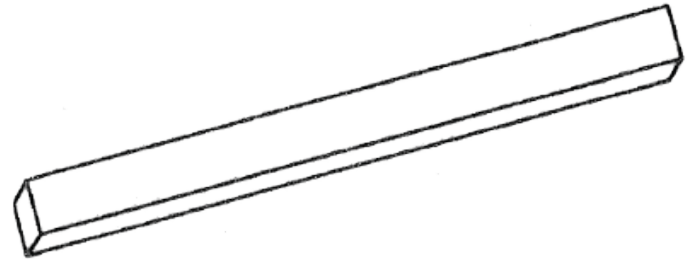



### PRODUCT INFORMATION

**MADE IN THE USA**

Item	Description	Quantity / Pallet	Weight (lbs / Pallet)
CFS0600	3" x 3" x 6"	744	3,300
CFS0650	3" x 3" x 6 1/2"	696	3,500
CSP0700	3" x 3" x 7"	608	3,200
CSP0750	3" x 3" x 7 1/2"	588	3,300
CSP0800	3" x 3" x 8"	480	2,900
CSP0900	3" x 3" x 9"	480	3,200
CSP1000	3" x 3" x 10"	480	3,600
CSP1200	3" x 3" x 12"	372	3,600
CSP4800	3" x 3" x 48"	112	4,000

### MANUFACTURER INFORMATION

-  (909) 356-5399
-  (909) 726-9500
-  [info@inlandconcreteproducts.com](mailto:info@inlandconcreteproducts.com)  
See user information at [inlandconcreteproducts.com](http://inlandconcreteproducts.com)



**Inland Concrete Products**  
14760 Santa Ana Ave.  
Fontana, CA 92337

## TECHNICAL DATA SHEETS

### DESCRIPTION

Our On Grade Square Concrete Chairs range in size from 1 1/2" to 6 1/4" in height. Each plastic high chair has two cover heights; for example, 1 1/2" and 1 3/4" is a single chair; 2" and 2 1/4" is a single chair, on up to 6" and 6 1/4". These plastic chairs have a wide, stable base designed to carry heavy loads in demanding on-grade applications. They also have large spacing between the legs for easy tying to rebar, maximum concrete flow and consolidation, and easy-to-read height markers.

### APPLICATION

- On grade.

### FEATURES

- Cover height from 1 1/2" to 6 1/4".
- Strong, stable, and easy to tie to rebar.
- Light and easy to carry.
- Works with mesh to #9 bar.

### PRODUCT INFORMATION

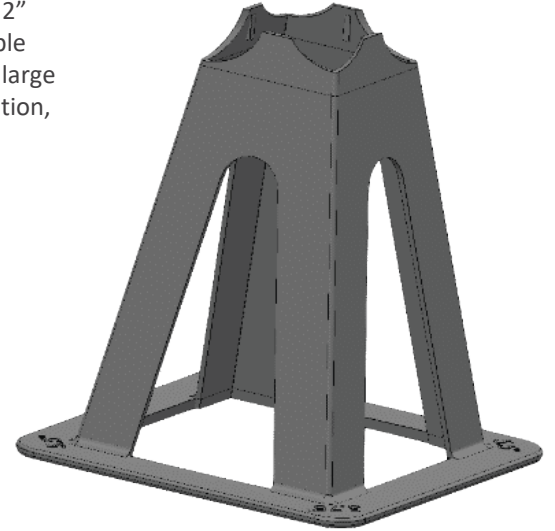

Item	Description	Pack	Quantity / Pack	Boxes / Pallet	Quantity / Pallet
<b>ON-GRADE150</b>	1 1/2" - 1 3/4"	Box	300	24	7,200
<b>ON-GRADE200</b>	2" - 2 1/4"	Box	400	16	6,400
<b>ON-GRADE250</b>	2 1/2" - 2 3/4"	Box	350	16	5,600
<b>ON-GRADE300</b>	3" - 3 1/4"	Box	288	16	4,608
<b>ON-GRADE350</b>	3 1/2" - 3 3/4"	Box	250	16	4,000
<b>ON-GRADE400</b>	4" - 4 1/4"	Box	200	16	3,200
<b>ON-GRADE450</b>	4 1/2" - 4 3/4"	Box	125	24	3,000
<b>ON-GRADE500</b>	5" - 5 1/4"	Box	100	24	2,400
<b>ON-GRADE550</b>	5 1/2" - 5 3/4"	Box	225	16	3,600
<b>ON-GRADE600</b>	6" - 6 1/4"	Box	200	16	3,200

**MADE IN THE USA • MADE FROM 100% RECYCLED MATERIAL**

 (909) 356-5399

 (909) 726-9500

 [info@inlandconcreteproducts.com](mailto:info@inlandconcreteproducts.com)

See user information at [inlandconcreteproducts.com](http://inlandconcreteproducts.com)



**Inland Concrete Products**  
14760 Santa Ana Ave.  
Fontana, CA 92337

## TECHNICAL DATA SHEETS

### DESCRIPTION

Our tilt chairs range in size from 3/4" to 6" in height. From 3/4" to 3" in height, each chair has a single cover height; above 3" there are two cover heights per chair, saving you time and space. These chairs have a wide, stable base with a footprint that is designed to work well in architectural applications, yet able to carry necessary loads and protect wood forms. They also have large spacing between the legs for easy tying to rebar, maximum concrete flow and consolidation, and large easy-to-read height markers.

### FEATURES

- Cover Heights from 3/4" to 6"
- Architectural footprint.
- Light weight and easy to use.
- Works with mesh to #9 bar.

### APPLICATION

- Tilt-up buildings, precast
- Anywhere architectural footprint is needed

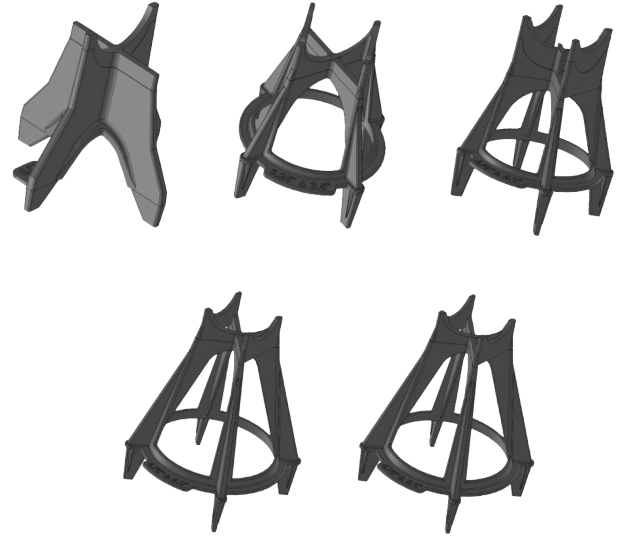



### PRODUCT INFORMATION

Item	Description	Pack	Quantity / Pack	Boxes / Pallet	Quantity / Pallet
TILT-CHAIR075	3/4"	Box	1,000	24	24,000
TILT-CHAIR100	1"	Box	850	24	20,400
TILT-CHAIR125	1 1/4"	Box	650	24	15,600
TILT-CHAIR150	1 1/2"	Box	500	24	12,000
TILT-CHAIR175	1 3/4"	Box	450	24	10,800
TILT-CHAIR200	2"	Box	350	24	8,400
TILT-CHAIR225	2 1/4"	Box	300	24	7,200
TILT-CHAIR250	2 1/2"	Box	350	24	8,400
TILT-CHAIR275	2 3/4"	Box	300	24	7,200
TILT-CHAIR300	3"	Box	260	24	6,240
TILT-CHAIR325/350	3 1/4" - 3 1/2"	Box	200	16	3,200
TILT-CHAIR375/400	3 3/4" - 4"	Box	200	16	3,200
TILT-CHAIR425/450	4 1/4" - 4 1/2"	Box	150	16	2,400
TILT-CHAIR475/500	4 3/4" - 5"	Box	150	16	2,400
TILT-CHAIR525/550	5 1/4" - 5 1/2"	Box	120	16	1,920
TILT-CHAIR575/600	5 3/4" - 6"	Box	100	16	1,600

**MADE IN THE USA • MADE FROM 100% RECYCLED MATERIAL**

 (909) 356-5399

 (909) 726-9500

 [info@inlandconcreteproducts.com](mailto:info@inlandconcreteproducts.com)

See user information at [inlandconcreteproducts.com](http://inlandconcreteproducts.com)



**Inland Concrete Products**  
14760 Santa Ana Ave.  
Fontana, CA 92337

## TECHNICAL DATA SHEETS

### DESCRIPTION

Our plastic rebar support “High Chairs” range in size from 3” to 14” in height. From 3” to 12 1/4” in height, each chair has two cover heights. Above 12 1/4” they have a single cover height per chair. Designed to be extremely strong yet able to straddle a lower rebar mat, these chairs have a wide, stable base with a footprint that is designed to work well in architectural applications, yet able to carry very heavy loads and protect wood forms.

Our innovative “Z” top provides maximum strength and ease of use, while providing for ease of access when tying to rebar. The Z-tops also have large spacing between the legs for maximum concrete flow and consolidation, and large easy-to-read height markers.

### FEATURES

- Cover Heights from 3” to 14”
- Bridge decks, Parking Structures, Foundations.
- On-grade applications with a sand plate.
- Works with mesh to #11 bar.

### APPLICATION

- Thick slabs
- Double rebar mats
- Heavy loads

### PRODUCT INFORMATION

Item	Description	Pack	Quantity / Pack	Boxes / Pallet	Quantity / Pallet
HI-CHAIR300/325	3" - 3 1/4"	Box	250	16	4,000
HI-CHAIR350/375	3 1/2" - 3 3/4"	Box	200	16	3,200
HI-CHAIR400/425	4" - 4 1/4"	Box	200	16	3,200
HI-CHAIR450/475	4 1/2" - 4 3/4"	Box	200	16	3,200
HI-CHAIR500/525	5" - 5 1/4"	Box	150	16	2,400
HI-CHAIR550/575	5 1/2" - 5 3/4"	Box	150	16	2,400
HI-CHAIR600/625	6" - 6 1/4"	Box	150	16	2,400
HI-CHAIR650/675	6 1/2" - 6 3/4"	Box	150	16	2,400
HI-CHAIR700/725	7" - 7 1/4"	Box	125	16	2,000
HI-CHAIR750/775	7 1/2" - 7 3/4"	Box	100	16	1,600
HI-CHAIR800/825	8" - 8 1/4"	Box	120	16	1,920
HI-CHAIR850/875	8 1/2" - 8 3/4"	Box	105	16	1,680
HI-CHAIR900/925	9" - 9 1/4"	Box	90	16	1,440
HI-CHAIR950/975	9 1/2" - 9 3/7"	Box	75	16	1,200
HI-CHAIR1000/1025	10" - 10 1/4"	Box	75	16	1,200
HI-CHAIR1050/1075	10 1/2" - 10 3/4"	Box	75	12	900
HI-CHAIR1100/1125	11" - 11 1/4"	Box	50	12	600
HI-CHAIR1150/1175	11 1/2" - 11 3/4"	Box	50	12	600
HI-CHAIR1200/1225	12" - 12 1/4"	Box	50	12	600
HI-CHAIR1250	12 1/2"	Box	50	12	600
HI-CHAIR1275	12 3/4"	Box	50	12	600
HI-CHAIR1300	13"	Box	50	12	600
HI-CHAIR1325	13 1/4"	Box	50	12	600
HI-CHAIR1350	13 1/2"	Box	50	12	600
HI-CHAIR1375	13 3/4"	Box	50	12	600
HI-CHAIR1400	14"	Box	30	12	360

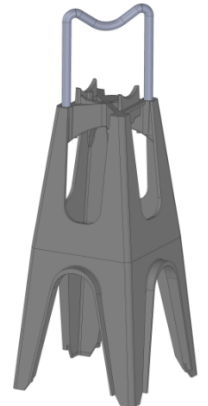
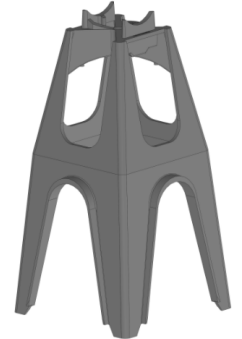
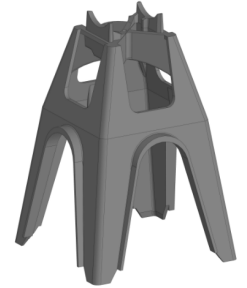
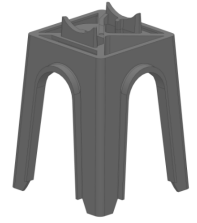

**MADE IN THE USA • MADE FROM 100% RECYCLED MATERIAL**

### MANUFACTURER INFORMATION

 (909) 356-5399

 (909) 726-9500

 [info@inlandconcreteproducts.com](mailto:info@inlandconcreteproducts.com)  
See user information at [inlandconcreteproducts.com](http://inlandconcreteproducts.com)



**Inland Concrete Products**  
14760 Santa Ana Ave.  
Fontana, CA 92337

## TECHNICAL DATA SHEETS

### DESCRIPTION

Our slab bolster ranges in size from 3/4" to 3" in height. Designed to be extremely strong and stable yet also able to work well in architectural applications, our bolster takes the industry to the next level. With the best coupler in the industry, your crew will find this bolster easy to place and securely connected, saving time and money. And with our form-guard leg tip design, you don't have to worry about the bolster damaging your expensive forms. Available in both 10-foot lengths bundled on a pallet, or in 2-½ foot lengths in boxes, we make it easy to place your rebar instead of messing around with inadequate supports.

### FEATURES

- Cover Heights from 3/4" to 3"
- Strong, excellent connection for part assembly.
- Form-guard tip design.

### APPLICATION

- Foundations, bridge decks.
- Parking structures, tilt-up walls.

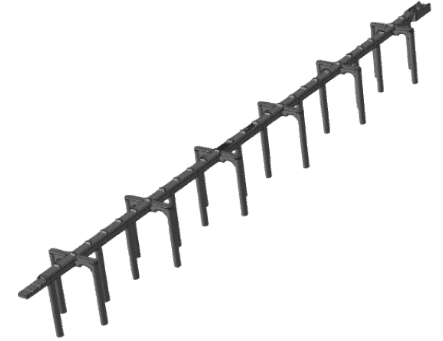

### PRODUCT INFORMATION

Item	Description	Pack	Quantity / Pack	Quantity / Pack
SLAB075HD-10FT	3/4"	BUNDLE	100	10,000
SLAB075HD-BOX	3/4"	BOX	250	5,000
SLAB100HD-10FT	1"	BUNDLE	100	10,000
SLAB100HD-BOX	1"	BOX	225	4,500
SLAB125HD-10FT	1 1/4"	BUNDLE	100	10,000
SLAB125HD-BOX	1 1/4"	BOX	225	4,500
SLAB150HD-10FT	1 1/2"	BUNDLE	100	10,000
SLAB150HD-BOX	1 1/2"	BOX	200	4,000
SLAB175HD-10FT	1 3/4"	BUNDLE	100	5,000
SLAB175HD-BOX	1 3/4"	BOX	150	3,000
SLAB200HD-10FT	2"	BUNDLE	100	5,000
SLAB200HD-BOX	2"	BOX	150	3,000
SLAB225HD-10FT	2 1/4"	BUNDLE	100	5,000
SLAB225HD-BOX	2 1/4"	BOX	125	2,500
SLAB250HD-10FT	2 1/2"	BUNDLE	100	5,000
SLAB250HD-BOX	2 1/2"	BOX	100	2,000
SLAB275HD-10FT	2 3/4"	BUNDLE	100	5,000
SLAB275HD-BOX	2 3/4"	BOX	100	2,000
SLAB300HD-10FT	3"	BUNDLE	100	5,000
SLAB300HD-BOX	3"	BOX	100	2,000

**MADE IN THE USA • MADE FROM 100% RECYCLED MATERIAL**

 (909) 356-5399

 (909) 726-9500

 [info@inlandconcreteproducts.com](mailto:info@inlandconcreteproducts.com)

See user information at [inlandconcreteproducts.com](http://inlandconcreteproducts.com)



**Inland Concrete Products**  
 14760 Santa Ana Ave.  
 Fontana, CA 92337

## TECHNICAL DATA SHEETS

### DESCRIPTION

Our sand plate is designed to work with all of our chairs. Whether you're using our high chairs or tilt chairs in an on-grade application, our sand plate attaches easily and securely to our chairs and provides for a large, stable base to ensure proper chair and rebar placement.

### APPLICATION

- On grade
- Works with all sizes of high chairs and tilt chairs.

### FEATURES

- Cover heights all sizes.
- On-grade use of our high chairs and tilt chairs.

### PRODUCT INFORMATION

**MADE IN THE USA • MADE FROM 100% RECYCLED MATERIAL**

Item	Description	Pack	Quantity / Pack	Boxes / Pallet	Quantity / Pallet
<b>SAND PLATE</b>	3/4" - 14"	BOX	200	16	3,200

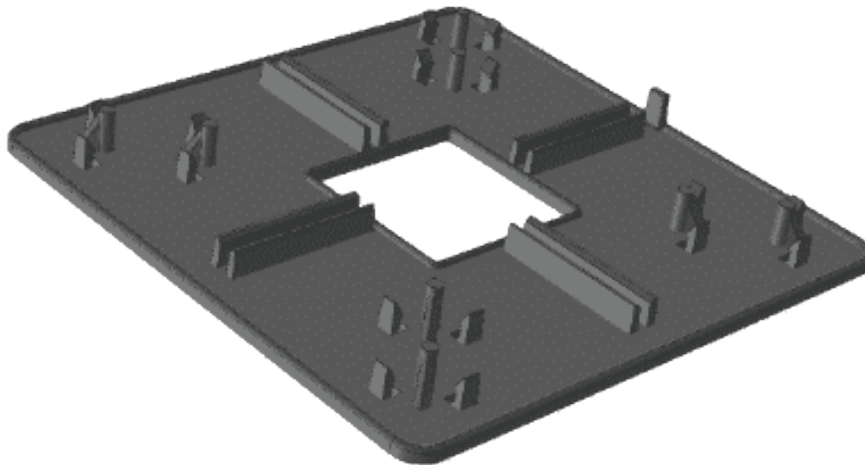

### MANUFACTURER INFORMATION

☎ (909) 356-5399

📠 (909) 726-9500

✉ [info@inlandconcreteproducts.com](mailto:info@inlandconcreteproducts.com)

See user information at [inlandconcreteproducts.com](http://inlandconcreteproducts.com)



**Inland Concrete Products**  
14760 Santa Ana Ave.  
Fontana, CA 92337

## TECHNICAL DATA SHEETS

### DESCRIPTION

Strong and stable, our screed chair is designed to support a lumber or pipe screed in a wide variety of applications. Users can cut a 1" O.D PVC pipe to the desired length and then fine tune the exact screed height with the durable and easy-to-adjust threaded ring supporting the screed receiver. Product is available as a complete set (base, adjustable ring, and receiver) or base only. The base measures 4-3/4" diagonally and is 1-1/4" high. The receiver is 2-3/8" wide on the outside, and has an adjustable range of approximately 1-1/2".

### APPLICATION

- On grade slab, elevated slab

### FEATURES

- Includes base, adjustable ring, and receiver.
- Base can be purchased separately.
- Fits 2x4 lumber and 1 1/2" diameter pipe screeds.
- Allows up to 1 1/2" height adjustment.
- 1" O.D. PVC pipe (sold separately) can be cut to any height.
- 300 lb. safe working load compression.

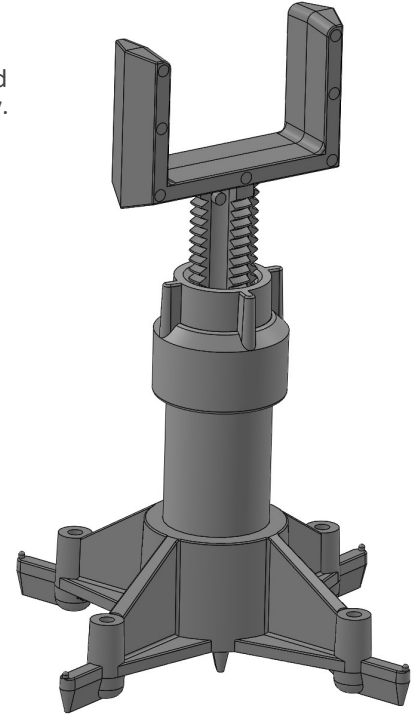

### PRODUCT INFORMATION

Item	Description	Pack	Quantity / Pack	Boxes / Pallet	Quantity / Pallet
<b>SCREED-BASE</b>	4 3/4" x 1 1/4"	BOX	200	24	4,800
<b>SCREED-CHAIR</b>	2 3/8" x 1 1/2"	BOX	100	24	2,400

### MANUFACTURER INFORMATION

 (909) 356-5399

 (909) 726-9500

 [info@inlandconcreteproducts.com](mailto:info@inlandconcreteproducts.com)

See user information at [inlandconcreteproducts.com](http://inlandconcreteproducts.com)



**Inland Concrete Products**  
14760 Santa Ana Ave.  
Fontana, CA 92337

## TECHNICAL DATA SHEETS

### DESCRIPTION

Our 3" locking wheel covers a wide range of typical bar sizes and provides for ease of use and secure installation. Whether you're spacing a caisson in a bridge structure or rebar in your precast facility, our wheel attaches securely and will be in the right place when the concrete is poured. Our improved zip tie design makes it easy to install the wheels and ensures that once installed, they are there to stay.

### APPLICATION

- Foundations, bridge decks.
- Parking structures, caissons, and precast.

### FEATURES

- Cover height 1 1/2" – 3"
- Strong, easy to use.
- Secure connection, multiple bar sizes.

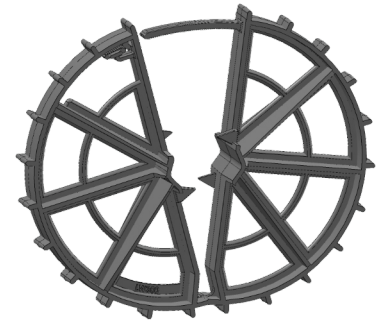
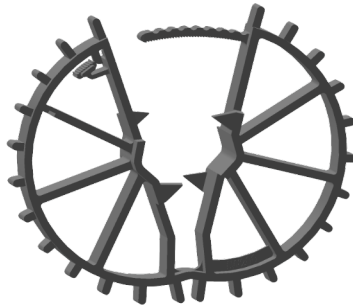
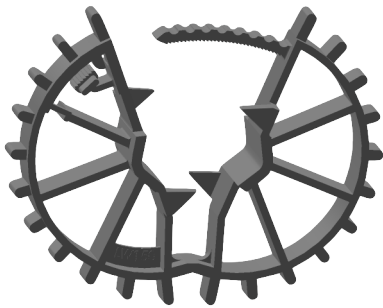



### PRODUCT INFORMATION

**MADE IN THE USA • MADE FROM 100% RECYCLED MATERIAL**

Item	Description	Pack	Quantity / Pack	Boxes / Pallet	Quantity / Pallet
LW150/6HD	1 1/2" for #3 to #6 Bar	Box	200	16	3,200
LW200/6HD	2" for #3 to #6 Bar	Box	200	16	3,200
LW250/6HD	2 1/2" for #3 to #6 Bar	Box	75	16	1,200
LW300/6	3" for #3 to #6 Bar	Box	50	16	800

### MANUFACTURER INFORMATION

 (909) 356-5399

 (909) 726-9500

 [info@inlandconcreteproducts.com](mailto:info@inlandconcreteproducts.com)

See user information at [inlandconcreteproducts.com](http://inlandconcreteproducts.com)



**Inland Concrete Products**  
14760 Santa Ana Ave.  
Fontana, CA 92337

## TECHNICAL DATA SHEETS

### DESCRIPTION

Our space wheels, ranging in size from ¾" cover to 3" cover, are designed for ease of installation and a secure connection to reinforcing steel or mesh. Our unique design allows for use of our space wheels on typical rebar sizes as well as #2 mesh setting us apart from the competition. Simply push our space wheel onto the reinforcing steel for a secure compression fit and in the case of #2 or #3 mesh or bar, lock the tabs in place for a secure connection.

### FEATURES

- Cover Heights from ¾" to 3"
- Strong, easy to use.
- Secure connection.

### APPLICATION

- Foundations, bridge decks.
- Parking structures, caissons, precast.





### PRODUCT INFORMATION

Item	Description	Pack	Quantity / Pack	Boxes / Pallet	Quantity / Pallet
SW075/4	¾" for #2 Mesh to #4 Bar	Box	1,150	24	27,600
SW100/6	1" for #2 Mesh to #6 Bar	Box	500	24	12,000
SW125/6	1 ¼" for #2 Mesh to #6 Bar	Box	375	24	9,000
SW150/6	1 ½" for #2 Mesh to #6 Bar	Box	300	16	4,800
SW200/6	2" for #2 Mesh to #6 Bar	Box	350	16	5,600
SW250/6	2 ½" for #2 Mesh to #6 Bar	Box	175	16	2,800
SW300/6	3" for #2 Mesh to #6 Bar	Box	200	16	3,200

**MADE IN THE USA • MADE FROM 100% RECYCLED MATERIAL**

### MANUFACTURER INFORMATION

 (909) 356-5399

 (909) 726-9500

 [info@inlandconcreteproducts.com](mailto:info@inlandconcreteproducts.com)

See user information at [inlandconcreteproducts.com](http://inlandconcreteproducts.com)



**Inland Concrete Products**  
14760 Santa Ana Ave.  
Fontana, CA 92337

## TECHNICAL DATA SHEETS

### DESCRIPTION

Our ProTilt Chairs® range in size from 3/4" to 3", in quarter inch increments. Each size of the ProTilt Chair® has two cover heights to reduce potential inventory storage requirements. The ProTilt Chair® has an extra wide footprint which contributes to a more sturdy and heavy duty chair that stays in place better than lighter weight alternatives. The added support directly underneath the cradle provides for additional strength. The footprint borrows elements from our slab bolster providing a best case scenario for use on form-work, mud slabs, and tilt-slab applications.

### FEATURES

- Cover Heights from 3/4" to 3"
- Strong, easy to use.
- Works with mesh to #9 bar.

### APPLICATIONS

- Tilt-up buildings and pre-cast.
- Anywhere architectural footprint is needed.

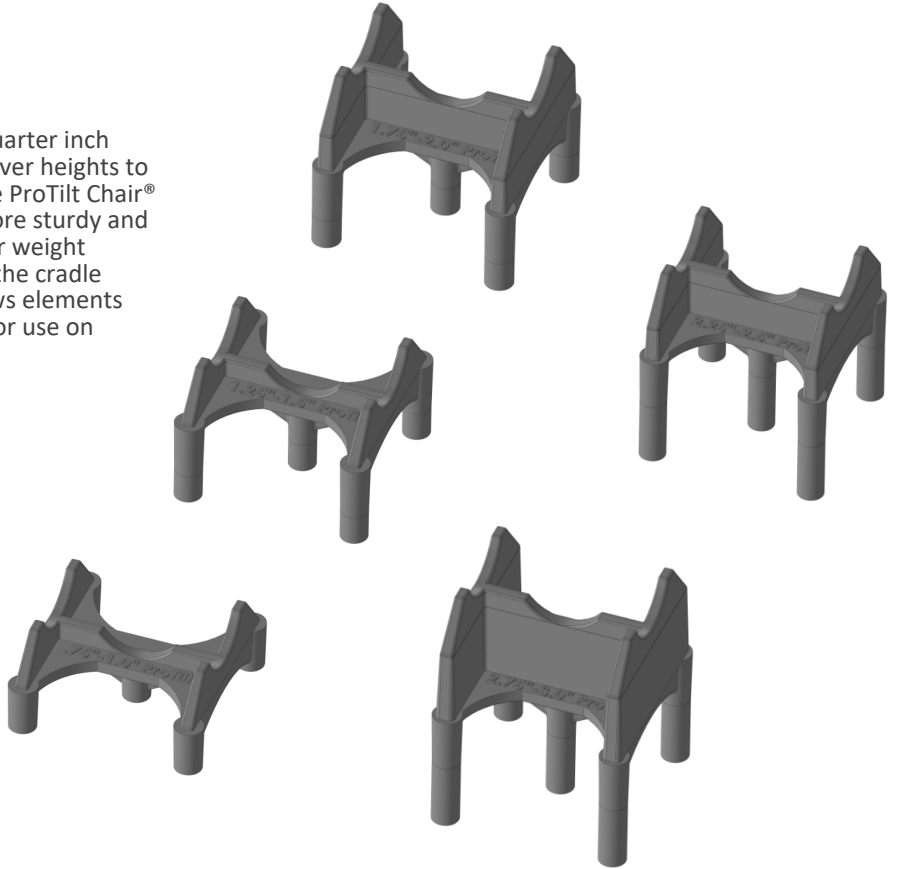

### PRODUCT INFORMATION

Item	Description	Pack	Quantity / Pack	Boxes / Pallet	Quantity / Pallet
<b>PROTILT-CHAIR 075/100</b>	3/4" & 1"	Box	700	16	11,200
<b>PROTILT-CHAIR 125/150</b>	1 1/4" & 1 1/2"	Box	500	16	8,000
<b>PROTILT-CHAIR 175/200</b>	1 3/4" & 2"	Box	300	16	4,800
<b>PROTILT-CHAIR 225/250</b>	2 1/4" & 2 1/2"	Box	250	16	4,000
<b>PROTILT-CHAIR 275/300</b>	2 3/4" & 3"	Box	200	16	3,200

**MADE IN THE USA • MADE FROM 100% RECYCLED MATERIAL**

### MANUFACTURER INFORMATION

☎ (909) 356-5399

📠 (909) 726-9500

✉ info@inlandconcreteproducts.com

See user information at inlandconcreteproducts.com



**Inland Concrete Products**  
14760 Santa Ana Ave.  
Fontana, CA 92337

## TECHNICAL DATA SHEETS

### DESCRIPTION

Designed for both strength and stability, our PROCHAIR® line delivers value and performance for the reinforced concrete professional. With 1/2" cover height increments, chair selection is simple and our industry-leading stack efficiency reduces costs. Better stacking means the chairs are less costly to store, less costly to ship and less costly to place in the field. Our PROCHAIR® products straddle lower mats, carry heavy loads, are easy to tie, and have a minimal footprint for tilt-up and architectural applications, while protecting costly form work.

### FEATURES

- Cover heights ranging from 1" to 7 3/4"
- Dual cover height in 1/2" increments.
- Strong, stable, easy to use.
- Excellent stacking and package density.
- Minimal footprint.
- Easy-to-read height markers.
- Works with mesh to #11 bar.

### APPLICATIONS

- Bridge decks, parking structures, foundations.
- Tilt-up buildings, precast.
- Thick slabs and thin slabs.
- Double rebar mats.

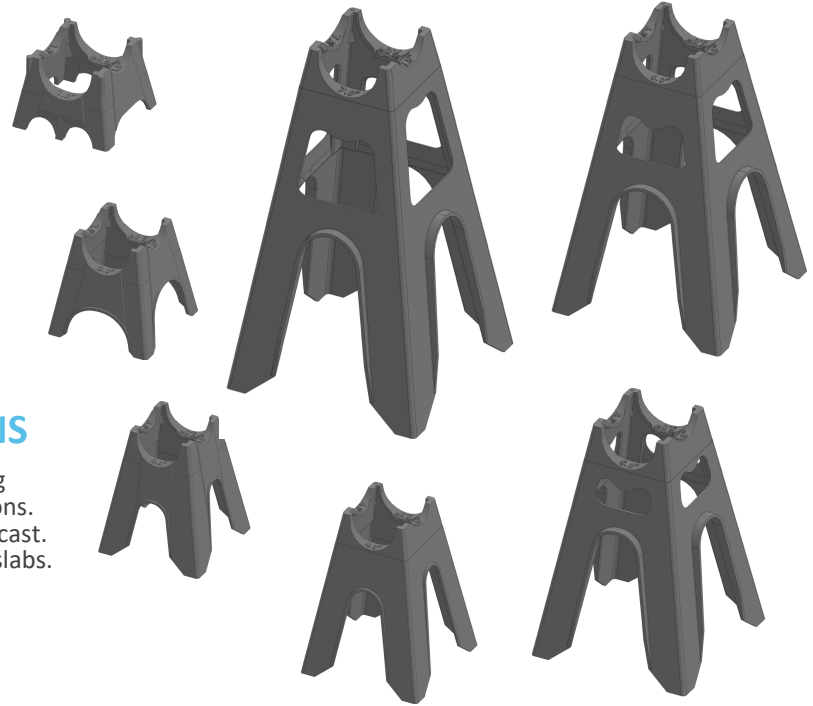

### PRODUCT INFORMATION

Item	Description	Pack	Quantity / Pack	Boxes / Pallet	Quantity / Pallet
PRO-CHAIR100/150	1" to 1 1/2"	Box	500	48	24,000
PRO-CHAIR125/175	1 1/4" to 1 3/4"	Box	500	48	24,000
PRO-CHAIR200/250	2" to 2 1/2"	Box	250	60	15,000
PRO-CHAIR225/275	2 1/4" to 2 3/4"	Box	250	60	15,000
PRO-CHAIR300/350	3" to 3 1/2"	Box	300	64	19,200
PRO-CHAIR325/375	3 1/4" to 3 3/4"	Box	300	64	19,200
PRO-CHAIR400/450	4" to 4 1/2"	Box	200	60	12,000
PRO-CHAIR425/475	4 1/4" to 4 3/4"	Box	200	60	12,000
PRO-CHAIR500/550	5" to 5 1/2"	Box	200	60	12,000
PRO-CHAIR525/575	5 1/4" to 5 3/4"	Box	200	60	12,000
PRO-CHAIR600/650	6" to 6 1/2"	Box	100	72	7,200
PRO-CHAIR625/675	6 1/4" to 6 3/4"	Box	100	72	7,200
PRO-CHAIR700/750	7" to 7 1/2"	Box	100	72	7,200
PRO-CHAIR725/775	7 1/4" to 7 3/4"	Box	100	72	7,200

**MADE IN THE USA • MADE FROM 100% RECYCLED MATERIAL**

### MANUFACTURER INFORMATION

☎ (909) 356-5399

📠 (909) 726-9500

✉ info@inlandconcreteproducts.com

See user information at inlandconcreteproducts.com



**Inland Concrete Products**  
14760 Santa Ana Ave.  
Fontana, CA 92337

## TECHNICAL DATA SHEETS

### DESCRIPTION

Designed for both strength and stability, our PROPAVING® line delivers value and performance for the reinforced concrete professional. With 1/4" cover height increments, our PROPAVING® product combines the engineered strength of an I-beam with a convenient and secure snap head feature that accommodates a #3 to #5 bar. With easy-to-read size markers our chair also has slots in the base of the chair that allows for stable On-Grade placement.

### FEATURES

- Cover heights ranging from 1 1/2" to 8"
- Snap head that works with a #3 to #5 bar.
- Strong, stable, easy to use.
- Slots on the base for easy placement.
- Easy-to-read height markers.

### APPLICATIONS

- Foundations, Slabs, Patios, driveways, any on-grade application.
- Highways and road construction.

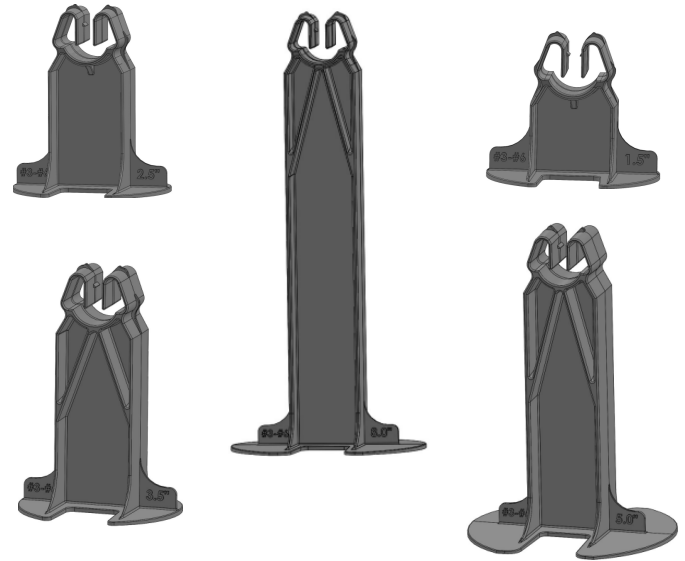

### PRODUCT INFORMATION

Item	Description	Pack	Quantity / Pack	Boxes / Pallet	Quantity / Pallet
PROPAVING-CHAIR150	1 1/2"	Box	200	36	7,200
PROPAVING-CHAIR175	1 3/4"	Box	200	36	7,200
PROPAVING-CHAIR200	2"	Box	175	36	6,300
PROPAVING-CHAIR225	2 1/4"	Box	175	36	6,300
PROPAVING-CHAIR250	2 1/2"	Box	150	36	5,400
PROPAVING-CHAIR275	2 3/4"	Box	150	36	5,400
PROPAVING-CHAIR300	3"	Box	225	16	3,600
PROPAVING-CHAIR325	3 1/4"	Box	200	16	3,200
PROPAVING-CHAIR350	3 1/2"	Box	200	16	3,200
PROPAVING-CHAIR375	3 3/4"	Box	200	16	3,200
PROPAVING-CHAIR400	4"	Box	150	24	3,600
PROPAVING-CHAIR425	4 1/4"	Box	150	24	3,600
PROPAVING-CHAIR450	4 1/2"	Box	150	16	2,400
PROPAVING-CHAIR475	4 3/4"	Box	150	16	2,400
PROPAVING-CHAIR500	5"	Box	150	16	2,400
PROPAVING-CHAIR525	5 1/4"	Box	150	16	2,400
PROPAVING-CHAIR550	5 1/2"	Box	175	16	2,800
PROPAVING-CHAIR575	5 3/4"	Box	175	16	2,800
PROPAVING-CHAIR600	6"	Box	175	16	2,800
PROPAVING-CHAIR625	6 1/4"	Box	150	16	2,400
PROPAVING-CHAIR650	6 1/2"	Box	150	16	2,400
PROPAVING-CHAIR675	6 3/4"	Box	150	16	2,400
PROPAVING-CHAIR700	7"	Box	150	16	2,400
PROPAVING-CHAIR725	7 1/4"	Box	150	16	2,400
PROPAVING-CHAIR750	7 1/2"	Box	150	16	2,400
PROPAVING-CHAIR775	7 3/4"	Box	150	16	2,400
PROPAVING-CHAIR800	8"	Box	150	16	2,400

### MANUFACTURER INFORMATION

MADE IN THE USA • MADE FROM 100% RECYCLED MATERIAL

☎ (909) 356-5399

🖨 (909) 726-9500

✉ info@inlandconcreteproducts.com

See user information at inlandconcreteproducts.com



**Inland Concrete Products**  
14760 Santa Ana Ave.  
Fontana, Ca 92337